



**THE DISPLAY CHOICE
OF PROFESSIONALS™**

www.agneovo.com

TX-10 LCD Monitor
User Manual

TABLE OF CONTENTS

SAFETY INFORMATION

WEEE.....	4
-----------	---

PRECAUTIONS

Notice	5
Cautions When Setting Up	5
Cautions When Using.....	6
Cleaning and Maintenance.....	7
Notice for the LCD Monitor.....	7

CHAPTER 1: PRODUCT DESCRIPTION

1.1 Package Contents	8
1.2 Removal and Fitting Cable Cover	9
1.3 Installing an Open Frame Monitor with L-Brackets	10
1.4 Wall Mounting.....	11
1.5 LCD Monitor Overview	12
1.6 Wired OSD Controller.....	13

CHAPTER 2: MAKING CONNECTIONS

2.1 Connecting the AC Power	14
2.2 Connecting Input Source Signals	15
2.3 Connecting Audio Devices	16
2.4 Connecting the Wired OSD Controller	16
2.5 Connecting USB for Touch Screen Control	17
2.6 Ventilation Requirements for Enclosure Locating.....	17

CHAPTER 3: USING THE LCD MONITOR

3.1 Turning on the Power	18
3.2 Displaying the OSD Menu	18
3.3 Adjusting Monitor Brightness.....	19
3.4 Adjusting Monitor Contrast	20
3.5 Using Auto Adjustment Function	21

CHAPTER 4: ON SCREEN DISPLAY MENU

4.1 Using the OSD Menu	22
4.2 OSD Menu Tree	24

CHAPTER 5: ADJUSTING THE LCD MONITOR

5.1 Picture Menu	25
5.2 Colour Menu.....	27
5.3 OSD Menu.....	28
5.4 System Menu	29

CHAPTER 6: APPENDIX

6.1 Warning Messages.....	30
6.2 Timing.....	31
6.3 Cleaning	31
6.4 Troubleshooting.....	32
6.5 Transporting the LCD Monitor	33

TABLE OF CONTENTS

CHAPTER 7: SPECIFICATIONS

7.1 Monitor Specifications	34
7.2 Monitor Dimensions.....	35

SAFETY INFORMATION

WEEE

Information for users applicable in European Union countries



The symbol on the product or its packaging signifies that this product has to be disposed separately from ordinary household wastes at its end of life. Please kindly be aware that this is your responsibility to dispose electronic equipment at recycling centers so as to help conserve natural resources. Each country in the European Union should have its collection centers for electrical and electronic equipment recycling. For information about your recycling drop off area, please contact your local related electrical and electronic equipment waste management authority or the retailer where you bought the product.

PRECAUTIONS

PRECAUTIONS

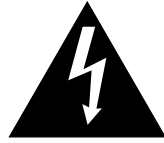

CAUTION
RISK OF ELECTRIC SHOCK
DO NOT OPEN



Symbols used in this manual



This icon indicates the existence of a potential hazard that could result in personal injury or damage to the product.



This icon indicates important operating and servicing information.

Notice

- Read this User Manual carefully before using the LCD monitor and keep it for future reference.
- The product specifications and other information provided in this User Manual are for reference only. All information is subject to change without notice. Updated content can be downloaded from our web site at www.agneovo.com.
- To protect your rights as a consumer, do not remove any stickers from the LCD monitor. Doing so may affect the determination of the warranty period.

Cautions When Setting Up



Do not place the LCD monitor near heat sources, such as a heater, exhaust vent, or in direct sunlight.



Do not cover or block the ventilation holes in the housing.



Place the LCD monitor on a stable area. Do not place the LCD monitor where it may be subject to vibration or shock.



Place the LCD monitor in a well-ventilated area.



Do not place the LCD monitor outdoors.



Do not place the LCD monitor in a dusty or humid environment.



Do not spill liquid or insert sharp objects into the LCD monitor through the ventilation holes. Doing so may cause accidental fire, electric shock or damage the LCD monitor.

PRECAUTIONS

Cautions When Using



Use only the power cord supplied with the LCD monitor.



The power outlet should be installed near the LCD monitor and be easily accessible.



If an extension cord is used with the LCD monitor, ensure that the total current consumption plugged into the power outlet does not exceed the ampere rating.



Do not allow anything to rest on the power cord. Do not place the LCD monitor where the power cord may be stepped on.



If the LCD monitor will not be used for an indefinite period of time, unplug the power cord from the power outlet.



To disconnect the power cord, grasp and pull by the plug head. Do not tug on the cord; doing so may cause fire or electric shock.



Do not unplug or touch the power cord with wet hands.



WARNING:

Unplug the power cord from the power outlet and refer to qualified service personnel under the following conditions:



- When the power cord is damaged.
- If the LCD monitor has been dropped or the housing has been damaged.
- If the LCD monitor emits smoke or a distinct odor.



Ceiling mount or mount on any other horizontal surface overhead are not advisable.



WARNING:

Installation in contravention of the instructions may result in undesirable consequences, particularly hurting people and damaging property. Users who have already mounted the monitor on the ceiling or any other horizontal surface overhead are strongly advised to contact AG Neovo for consultations and solutions to help ensure a most pleasurable and fulfilling monitor experience.

PRECAUTIONS

Cleaning and Maintenance



Do not attempt to service the LCD monitor yourself, refer to qualified service personnel.

Opening or removing the covers may expose you to dangerous voltage or other risks.

Notice for the LCD Monitor

In order to maintain the stable luminous performance, it is recommended to use low brightness setting.

Due to the lifespan of the lamp, it is normal that the brightness quality of the LCD monitor may decrease with time.

When static images are displayed for long periods of time, the image may cause an imprint on the LCD monitor. This is called image retention or burn-in.

To prevent image retention, do any of the following:

- Set the LCD monitor to turn off after a few minutes of being idle.
- Use a screen saver that has moving graphics or a blank white image.
- Switch desktop backgrounds regularly.
- Adjust the LCD monitor to low brightness settings.
- Turn off the LCD monitor when the system is not in use.

Things to do when the LCD monitor shows image retention:

- Turn off the LCD monitor for extended periods of time. It can be several hours or several days.
 - Use a screen saver and run it for extended periods of time.
 - Use a black and white image and run it for extended periods of time.
-

There are millions of micro transistors inside the LCD monitor. It is normal for a few transistors to be damaged and to produce spots. This is acceptable and is not considered a failure.

CHAPTER 1: PRODUCT DESCRIPTION

1.1 Package Contents

When unpacking, check if the following items are included in the package. If any of them is missing or damaged, contact your dealer.

LCD Monitor

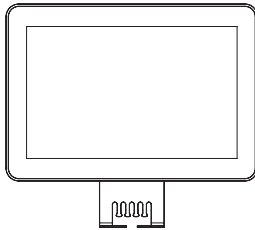

Quick Start Guide



Warranty Card

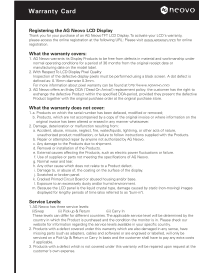

Wired OSD Controller

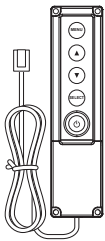

Power Adapter^(*)

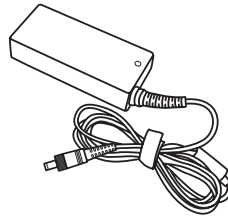

Power Cord

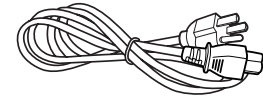

VGA Cable

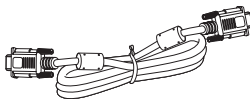

DisplayPort Cable

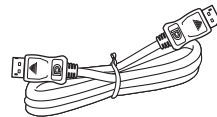

USB Cable
(Touch Function)

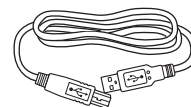

Side Bracket Package

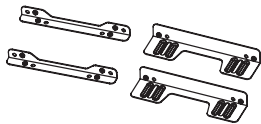

Screw Package



M4 x 8pcs

Note:

- Use only the supplied power cord.
- The above pictures are for reference only. Actual items may vary upon shipment.
- (*) Must use only the supplied power adapter:
 - Vendor: DELTA ELECTRONICS, INC.
 - Model no.: ADP-36PH BBE
 - Rating: DC 12V, 3A

PRODUCT DESCRIPTION

1.2 Removal and Fitting Cable Cover

1. Remove the screw securing the cable cover. Then remove the cable cover from the monitor.

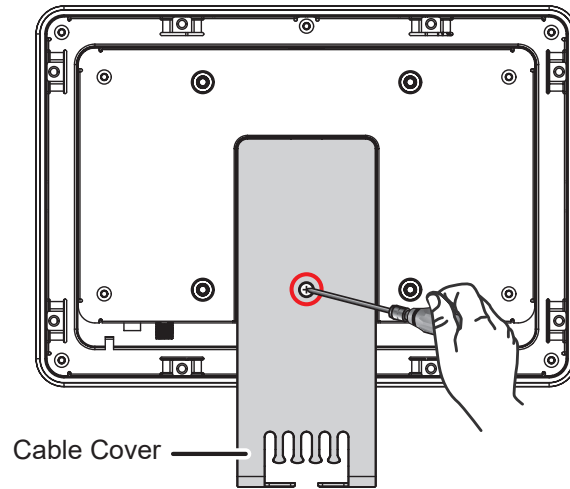

2. Connect the cables and route them through the slots on the cable cover.
3. Install the cable cover and secure it using a screw.

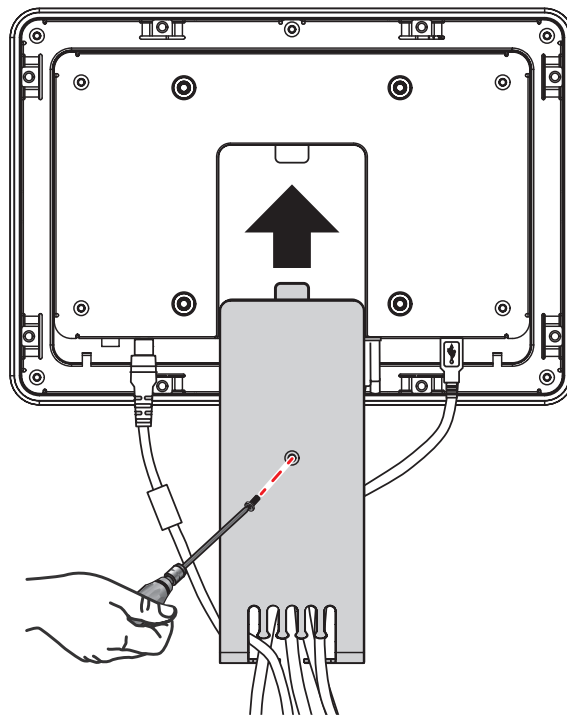

PRODUCT DESCRIPTION

4. Secure the cables to the cable cover using the cable ties.

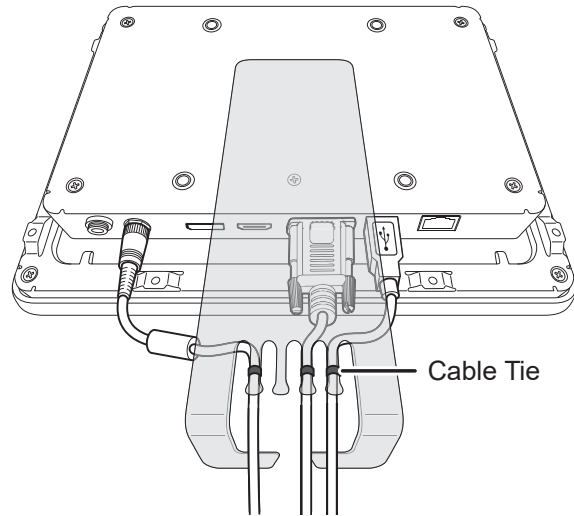

1.3 Installing an Open Frame Monitor with L-Brackets

To install an open frame monitor with L-brackets, you need the following items:



Bracket 1 X 2pcs

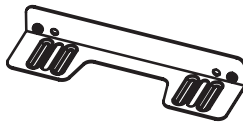

Bracket 2 X 2pcs



Screw M4 X 8pcs

1. Install the two Bracket 1 to the rear of the monitor. Then secure the brackets using the four screws.

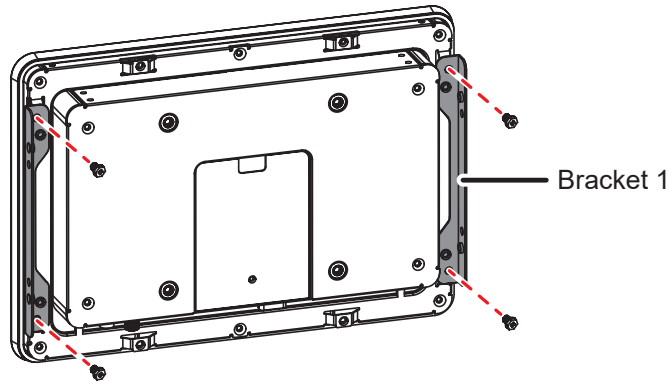

2. Install the two Bracket 2 to the customer's cabinet. Then secure the brackets using the four screws.

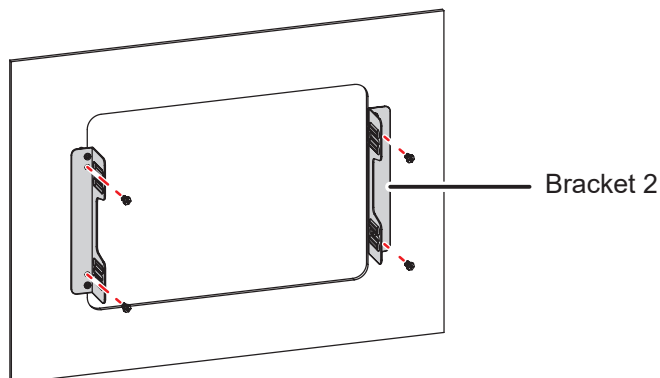

PRODUCT DESCRIPTION

3. Align the screw holes of the Bracket 1 with the screw holes of the Bracket 2. Then assemble the L-bracket by securing the brackets using the screws.

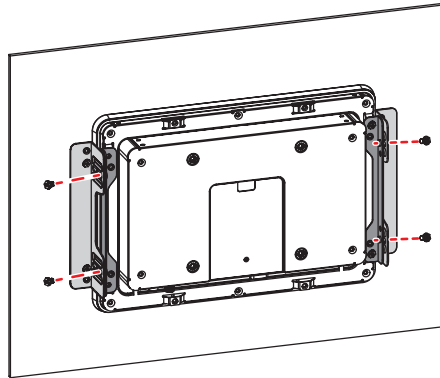

1.4 Wall Mounting

To wall-mount the LCD monitor, screw the mounting bracket to the VESA holes at the rear of the LCD monitor.

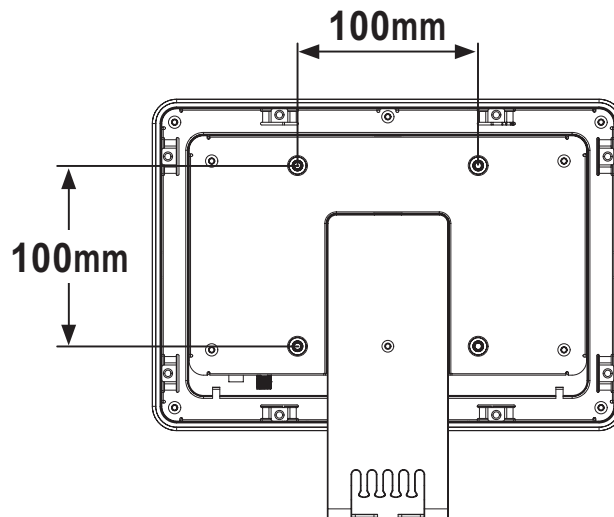

Note: Take measures to prevent the LCD monitor from falling down and lessen possible injury and damage to the monitor in case of earthquakes or other disasters.

- Use only the 100 x 100 mm wall mount kit recommended by AG Neovo. All AG Neovo wall mount kits comply with VESA standard.
- Secure the LCD monitor on a solid wall strong enough to bear its weight.
- It is suggested to wall mount the LCD monitor without tilting it facing downward.

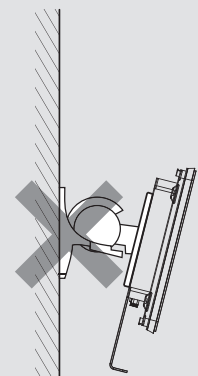

PRODUCT DESCRIPTION

1.5 LCD Monitor Overview

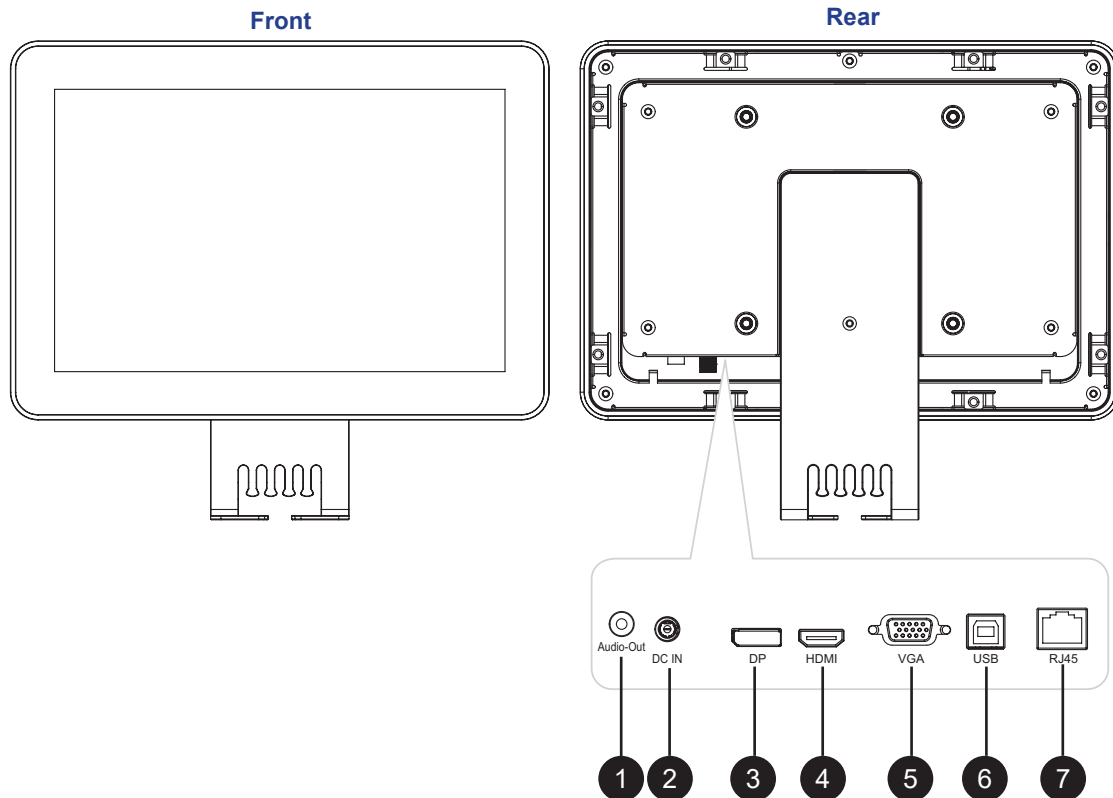

1

Audio OUT:

Connect audio signals output (3.5 mm Stereo Audio Jack). Only applicable for DisplayPort or HDMI input signal.

2

DC IN:

Connect with the supplied power adaptor.

3

DisplayPort IN:

Connect DisplayPort signals input.

4

HDMI IN:

Connect HDMI signals input.

5

VGA IN:

Connect VGA signals input.

6

USB Type-B Port (Touch):

Connect USB for touch screen control.

7

Wired OSD Controller Port (RJ45):

Connect the wired OSD controller.

PRODUCT DESCRIPTION

1.6 Wired OSD Controller

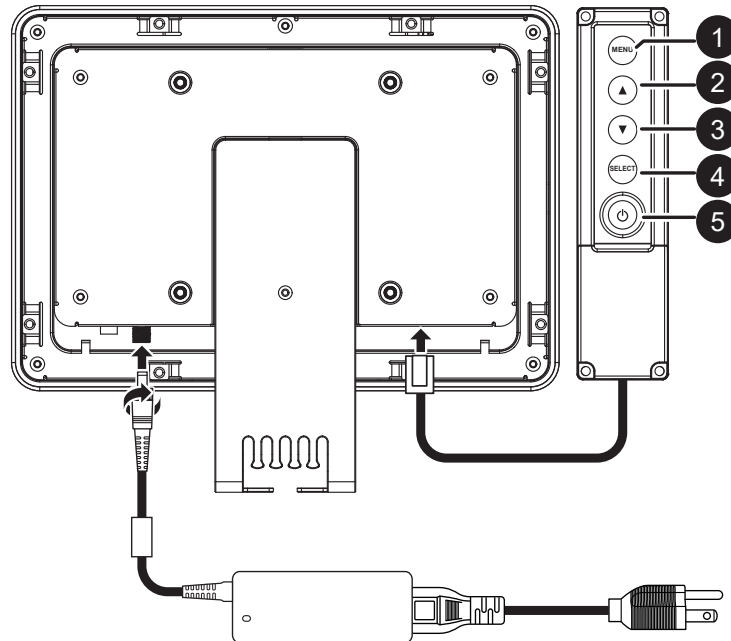

1

MENU:

- Press to display OSD menu.
- When OSD menu is ON, press to hide OSD menu or return to the previous menu.

2

UP (▲):

- Press to display the Brightness quick menu. Press the ▲/▼ key to adjust the brightness level.
- When OSD menu is ON, press to select a main item, select sub-item function, or adjust the settings.

3

DOWN (▼):

- Press to display the Contrast quick menu. Press the ▲/▼ key to adjust the contrast level.
- When OSD menu is ON, press to select a main item, select sub-item function, or adjust the settings.

4

SELECT:

- For VGA input signal source, press to perform auto adjustment.
- When OSD menu is ON, press to confirm the selection or select sub-item function.

5

POWER (⏻):

Press to turn the power on or off.

CHAPTER 2: MAKING CONNECTIONS



CAUTION:

Make sure that the LCD monitor is not connected to the power outlet before making any connections. Connecting cables while the power is ON may cause possible electric shock or personal injury.

2.1 Connecting the AC Power

1. Connect the power cord to the power adapter.
2. Connect the power adapter to the DC power input at the rear of the LCD monitor.
3. Connect the power cord plug to a power outlet or a power supply.

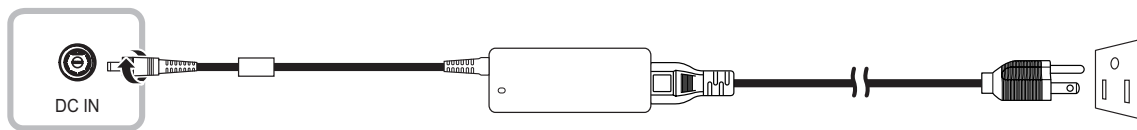

CAUTION:

When unplugging the power cord, hold the power cord by the plug head. Never pull by the cord.

MAKING CONNECTIONS

2.2 Connecting Input Source Signals

Input source signals can be connected with either of the following cables:

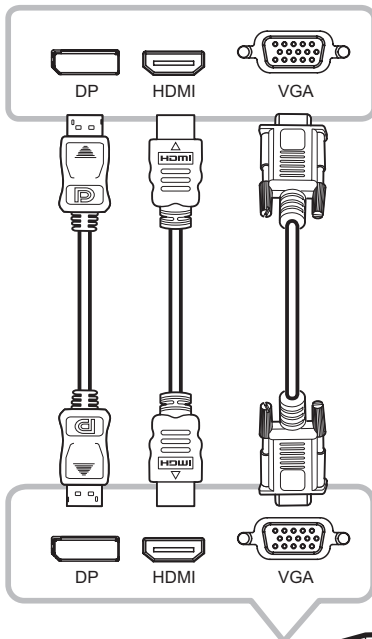

- **DP**

Connect one end of a DP cable to the DP connector of the LCD monitor and the other end to the DP connector of the computer.

- **HDMI**

Connect one end of an HDMI cable to the HDMI connector of the LCD monitor and the other end to the HDMI connector of the computer.

- **VGA**

Connect one end of a D-Sub (VGA) cable to the D-Sub (VGA) connector of the LCD monitor and the other end to the D-Sub (VGA) connector of the computer.

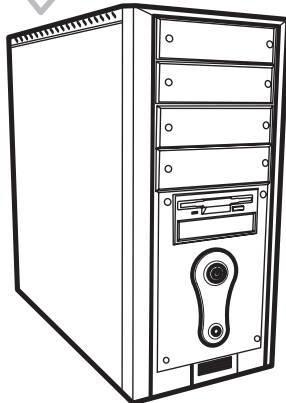

MAKING CONNECTIONS

2.3 Connecting Audio Devices

- **Audio Output**

Connect a headphone to the headphone jack of the LCD monitor.

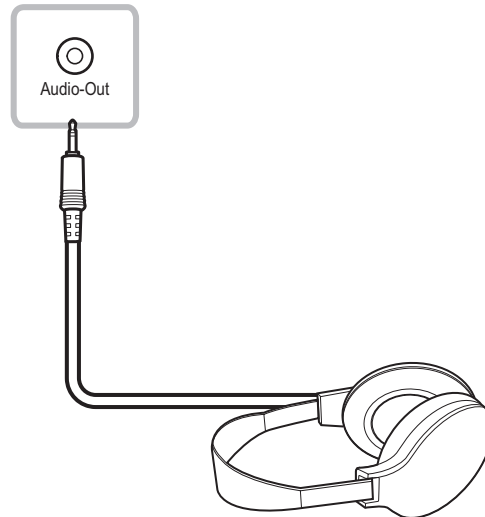

2.4 Connecting the Wired OSD Controller

Connect the wired OSD controller to the RJ45 connector of the LCD monitor.

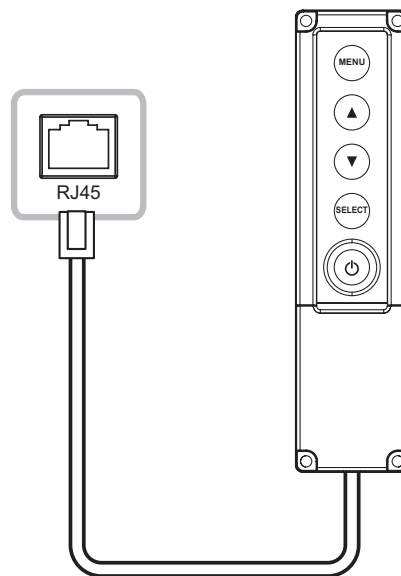

MAKING CONNECTIONS

2.5 Connecting USB for Touch Screen Control

Connect one end of a USB cable to the USB connector of the LCD monitor and the other end to the USB connector of the computer.

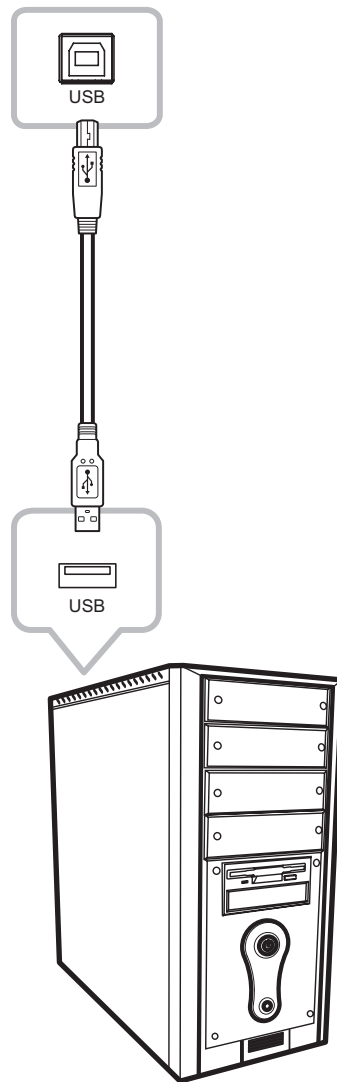

2.6 Ventilation Requirements for Enclosure Locating

To allow heat to disperse, avoid installing the LCD monitor directly on the cabinet wall and make sure the operating/storage temperature/humidity requirements are met as described below:

- Operating temperature (independent of altitude): 0°C-50°C (32°F-122°F)
- Non-operating temperature (independent of altitude): -20°C-60°C (-4°F-140°F)
- Operating humidity (non-condensing): 20%-80%
- Non-operating humidity (38.7°C (101.7°F) maximum wet bulb temperature): 10%-90%

CHAPTER 3: USING THE LCD MONITOR

3.1 Turning on the Power

1. Connect the power to the LCD monitor. Refer to page 14.
2. Connect the wired OSD controller to the LCD monitor. Refer to page 16.
3. Press the  key on the wired OSD controller to turn the LCD monitor on.

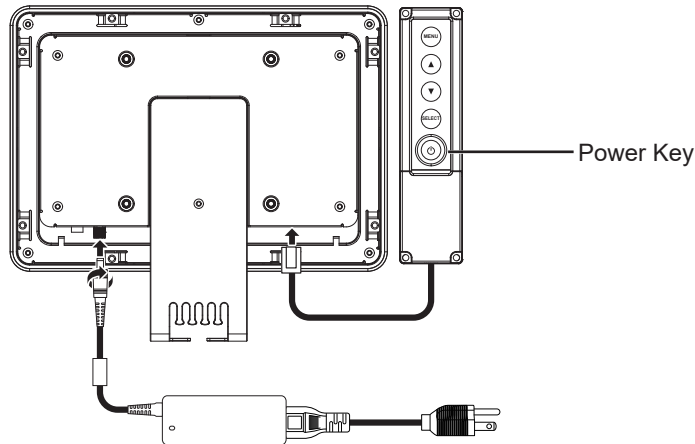

When the LCD monitor is turned on, press the  key on the wired OSD controller to turn off the LCD monitor.

Note: The LCD monitor still consumes power as long as the power cord is connected to the power outlet. Disconnect the power cord to completely cut off power.

3.2 Displaying the OSD Menu

Press the MENU key to open the OSD menu. Press the MENU key again to close the OSD menu.

For more information on adjusting settings, refer to page 22.

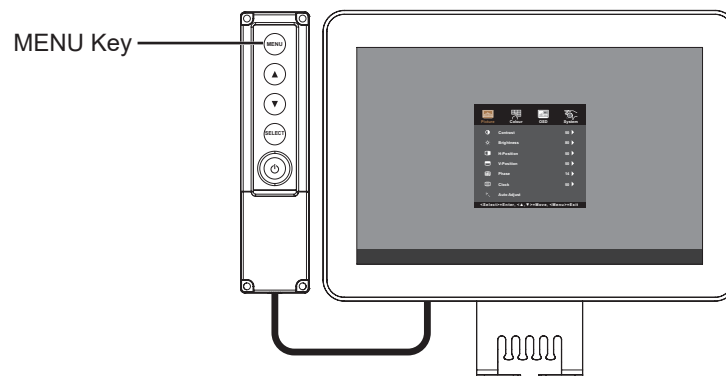

USING THE LCD MONITOR

The following menu appears on the screen:

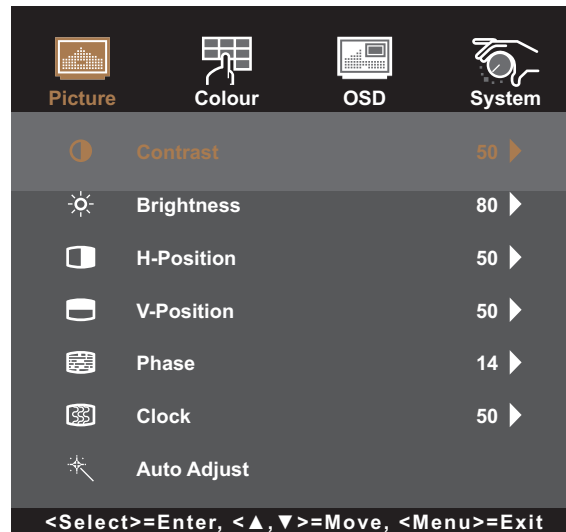

3.3 Adjusting Monitor Brightness

Press the ▲ key to open the Brightness quick menu.

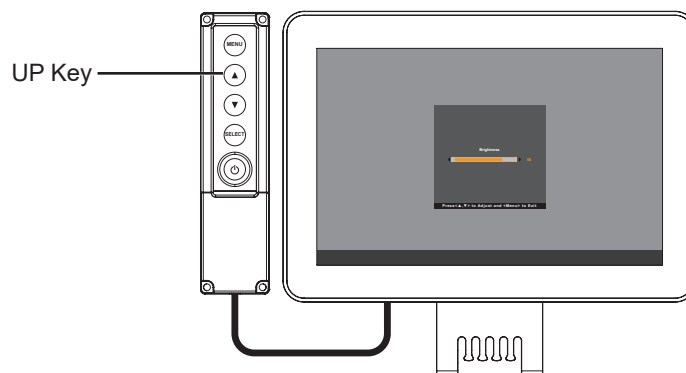

The following menu appears on the screen:

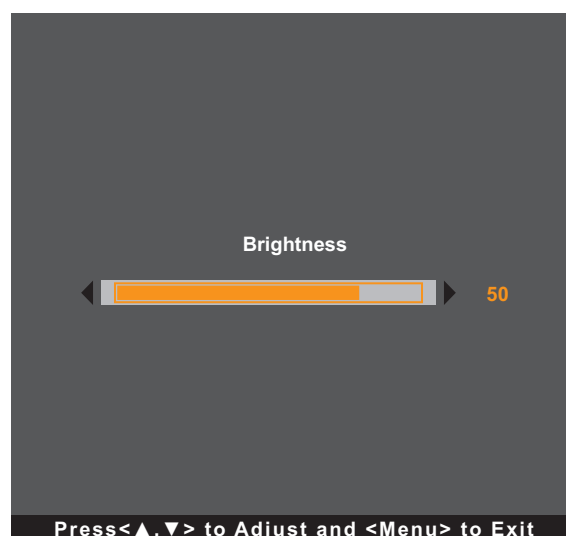

Then press the ▲/▼ keys to adjust the LCD monitor brightness level.

USING THE LCD MONITOR

3.4 Adjusting Monitor Contrast

Press the ▼ key to open the Contrast quick menu.

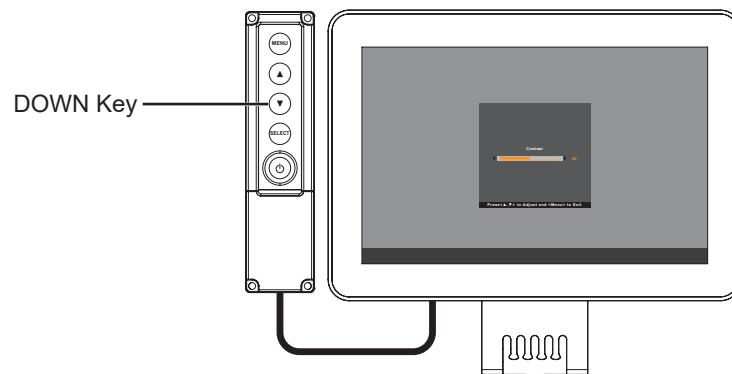

The following menu appears on the screen:

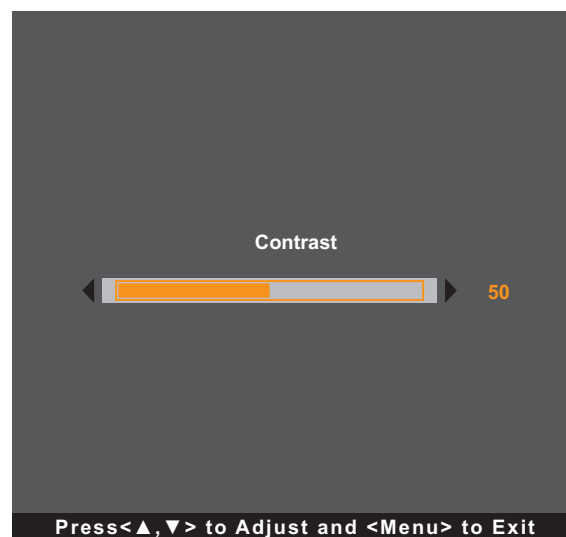

Then press the ▲/▼ keys to adjust the LCD monitor contrast level.

USING THE LCD MONITOR

3.5 Using Auto Adjustment Function

Auto Adjustment function automatically tunes the LCD monitor to its optimal setting, including horizontal position, vertical position, clock, and phase.

Press the SELECT key to perform auto adjustment if the source is VGA.

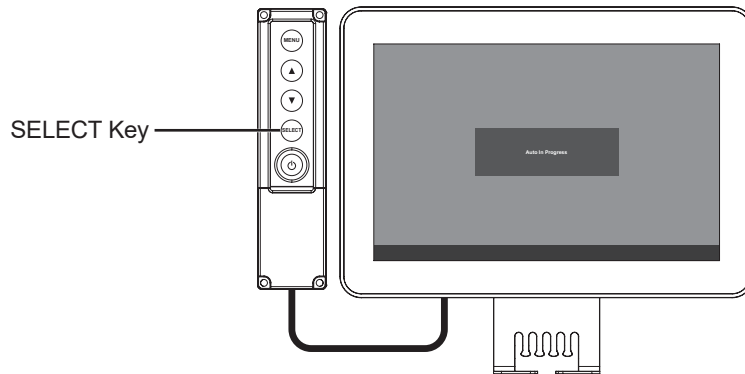

During the auto adjustment, the screen will slightly shake for a few seconds and you will see the following message:

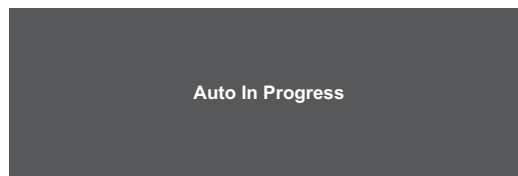

When the message disappears, auto adjustment is completed.

Note: *It is recommended to use the auto adjustment function when using the LCD monitor for the first time or after a resolution change.*

CHAPTER 4: ON SCREEN MONITOR MENU

4.1 Using the OSD Menu

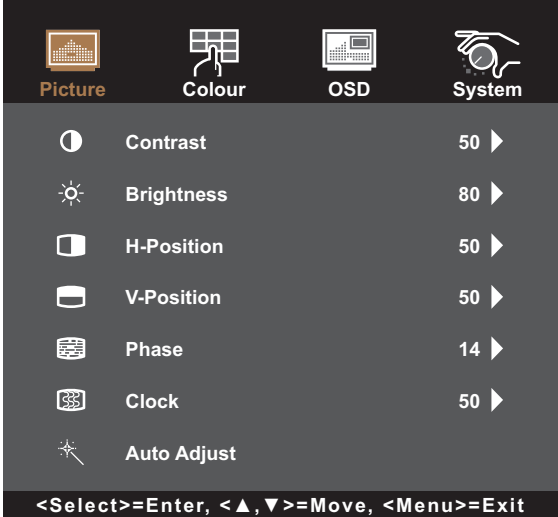
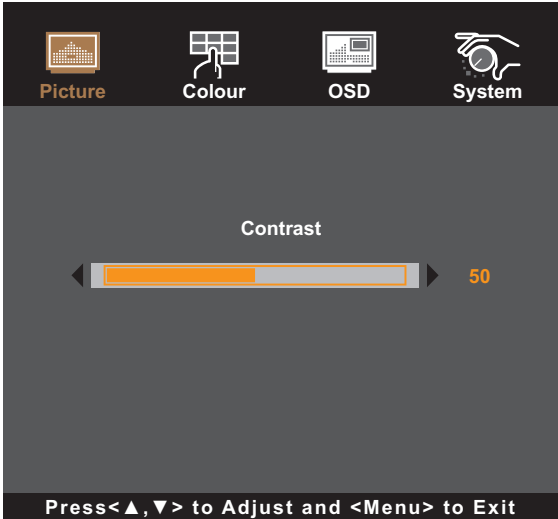
#	Menu Navigation	Operation
1	<p>Display the main menu screen.</p> 	<p>Press MENU on the wired OSD controller.</p>
2	<p>Enter the submenu.</p>  <p>The active main menu and submenu icon is highlighted in orange.</p>	<ol style="list-style-type: none"> 1 Press ▲/▼ to select the main menu item. 2 Press SELECT to enter the submenu. 3 Press ▲/▼ to select the submenu item. 4 Press SELECT to enter the selected submenu.

ON SCREEN MONITOR MENU

#	Menu Navigation	Operation
3	Adjust the settings or select the value. For example: 	<ol style="list-style-type: none"> 1 Press ▲/▼ to adjust the value or select the setting. 2 Press SELECT to confirm the setting (if necessary).
4	Return to the previous menu and/or close the OSD window.	Press MENU once to return to the previous menu. Press MENU repeatedly (if necessary) to close the OSD window.

Note: When settings are modified, all changes are saved when the user does the following:

- Proceeds to another menu
- Exits the OSD menu
- Waits for the OSD menu to disappear

ON SCREEN MONITOR MENU

4.2 OSD Menu Tree

Main Menu	Submenu	Reference
Picture	Contrast	Refer to page 25.
	Brightness	
	H-Position	
	V-Position	
	Phase	
	Clock	
	Auto Adjust	
Colour	Colour	Refer to page 27.
	Red	
	Green	
	Blue	
	Sharpness	
OSD	OSD Timeout	Refer to page 28.
	OSD Position	
	OSD H-Position	
	OSD V-Position	
System	Reset	Refer to page 29.
	Language	
	Source Select	
	Information	
	Factory	



Note: Availability of some menu items depend on the input source signal. If the menu is not available, it is disabled and greyed out.

CHAPTER 5: ADJUSTING THE LCD MONITOR

5.1 Picture Menu

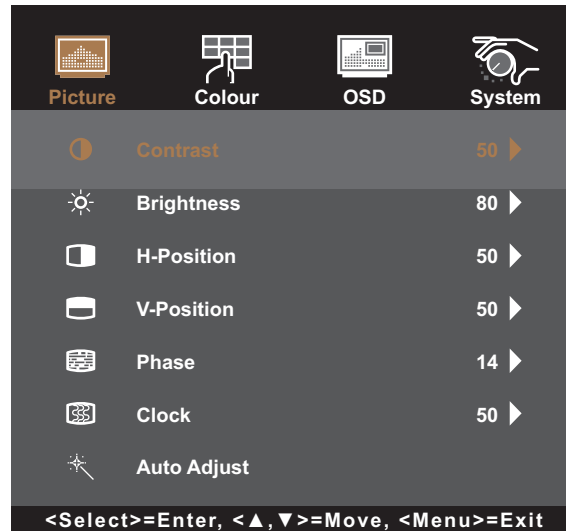
1. Press MENU on the wired OSD controller to call out the OSD window.
2. Press ▲/▼ to select Picture and then press SELECT to enter the menu.
3. Press ▲/▼ to select the submenu item and then press SELECT to enter its settings.

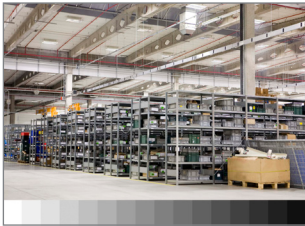
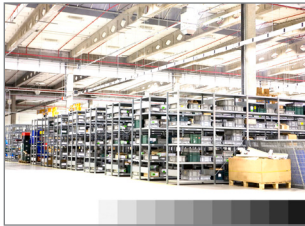
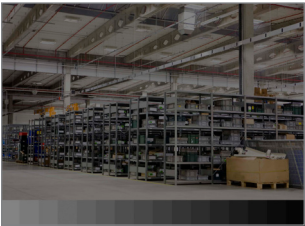
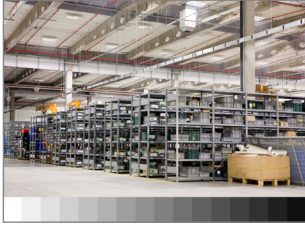

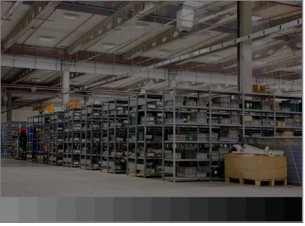
Item	Function	Operation	Range
Contrast	Adjusts the difference between the black level and the white level.	Press ▲/▼ to adjust the value.	0 to 100
	<div style="display: flex; justify-content: space-around;"> <div style="text-align: center;"> <p><i>Original Setting</i></p>  </div> <div style="text-align: center;"> <p><i>High Setting</i></p>  </div> <div style="text-align: center;"> <p><i>Low Setting</i></p>  </div> </div>		
Brightness	Adjusts the luminance of the screen image.	Press ▲/▼ to adjust the value.	0 to 100
	<div style="display: flex; justify-content: space-around;"> <div style="text-align: center;"> <p><i>Original Setting</i></p>  </div> <div style="text-align: center;"> <p><i>High Setting</i></p>  </div> <div style="text-align: center;"> <p><i>Low Setting</i></p>  </div> </div>		
H-Position (Horizontal Position)	Moves the screen image to the left or to the right.	Press ▲/▼ to adjust the value.	0 to 100
	<p>Note: This menu item is only available if the source is VGA.</p>		

ADJUSTING THE LCD MONITOR

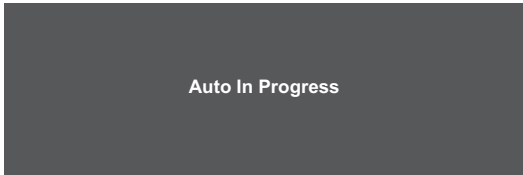
Item	Function	Operation	Range
V-Position (Vertical Position)	Moves the screen image up or down. Note: <i>This menu item is only available if the source is VGA.</i>	Press ▲/▼ to adjust the value.	0 to 100
Phase	Adjusts the phase timing to synchronise with the video signal. Note: <i>This menu item is only available if the source is VGA.</i>	Press ▲/▼ to adjust the value.	0 to 100
Clock	Adjusts the frequency timing to synchronise with the video signal. Note: <i>This menu item is only available if the source is VGA.</i>	Press ▲/▼ to adjust the value.	0 to 100
Auto Adjust	Automatically optimises image display.  Note: <i>This menu item is only available if the source is VGA.</i>	Press ▲/▼ to select the setting and then press SELECT to confirm.	No Yes

ADJUSTING THE LCD MONITOR

5.2 Colour Menu

1. Press MENU on the wired OSD controller to call out the OSD window.
2. Press ▲/▼ to select Colour and then press SELECT to enter the menu.
3. Press ▲/▼ to select the submenu item and then press SELECT to enter its settings.

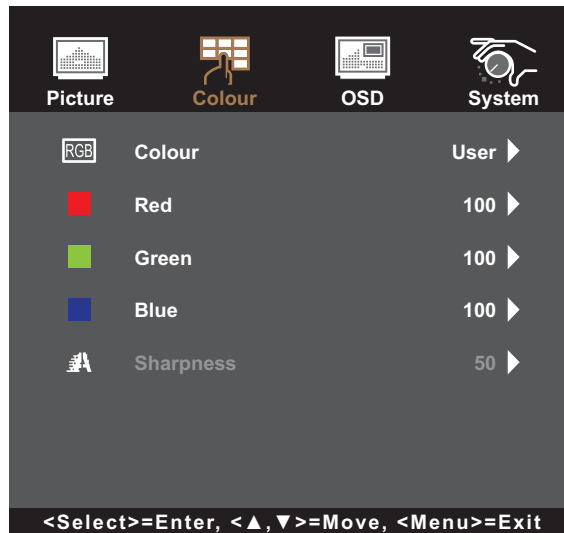

Item	Function	Operation	Range
Colour	Provides several colour adjustment settings.	Press ▲/▼ to select the setting and then press SELECT to confirm.	5500K 6500K 7500K 9300K User
	Colour temperature can be set to: <ul style="list-style-type: none"> • 5500K: Applies a reddish tint for warmer colours. • 6500K: This is the default colour temperature commonly used for normal lighting conditions. • 7500K: Applies the screen colour between red and blue. • 9300K: Applies a bluish tint for cooler colours. • User: This allows users to set the colour temperature by adjusting the Red, Green, and Blue value according to one's preference. 		
Sharpness	Adjusts the clarity and focus of the screen image.	Press ▲/▼ to adjust the value.	0 to 100

ADJUSTING THE LCD MONITOR

5.3 OSD Menu

1. Press MENU on the wired OSD controller to call out the OSD window.
2. Press ▲/▼ to select OSD and then press SELECT to enter the menu.
3. Press ▲/▼ to select the submenu item and then press SELECT to enter its settings.



Item	Function	Operation	Range
OSD Timeout	Sets the length of time (in seconds) the OSD screen is displayed. When the time elapses, the OSD screen is automatically inactivated.	Press ▲/▼ to adjust the value.	5 to 60
OSD Position	Sets the OSD window location on the screen.	Press ▲/▼ to select the setting and then press SELECT to confirm.	User-defined
OSD H-Position (Horizontal Position)	Moves the OSD window to the left or right of the screen.	Press ▲/▼ to adjust the value.	0 to 100
OSD V-Position (Vertical Position)	Moves the OSD window up or down the screen.	Press ▲/▼ to adjust the value.	0 to 100

ADJUSTING THE LCD MONITOR

5.4 System Menu

1. Press MENU on the wired OSD controller to call out the OSD window.
2. Press ▲/▼ to select System and then press SELECT to enter the menu.
3. Press ▲/▼ to select the submenu item and then press SELECT to enter its settings.

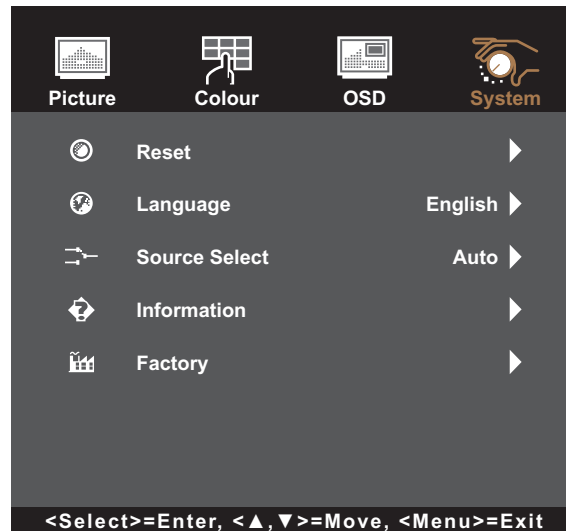



Item	Function	Operation	Range
Reset	Resets the device to the factory default settings.	Press ▲/▼ to select the setting and then press SELECT to confirm.	No Yes
Language	Selects the language used for OSD menus.	Press ▲/▼ to select the setting and then press SELECT to confirm.	English Français Deutsch Italiano Español 日本語 繁中 簡中
Source Select	Sets the input source. Note: <i>If the source is set to "Auto" then the monitor detects the input source automatically.</i>	Press ▲/▼ to select the setting and then press SELECT to confirm.	Auto VGA HDMI DP
Information	View the source, resolution, and frequency.	Press MENU to return to the System menu.	N/A
Factory	This maintenance function is for the serviceman to operate.	N/A	N/A

CHAPTER 6: APPENDIX

6.1 Warning Messages

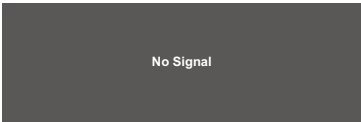
When any of these warning messages appear, check the following items.

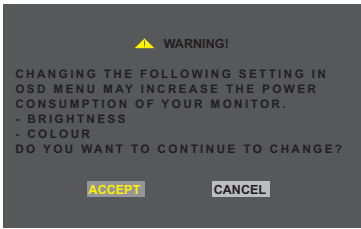
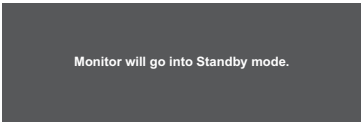
Warning Message	Cause	Solution
 <p>No Signal</p>	<p>The LCD monitor cannot detect the input source signal.</p>	<ul style="list-style-type: none"> √ Check if the input source is turned ON. √ Check if the signal cable is properly connected. √ Check if any pin inside the cable connector is twisted or broken.
 <p>Out of Range</p>	<p>The resolution or the refresh rate of the graphics card of the computer is set too high.</p> <div style="border: 1px solid gray; padding: 5px; margin-top: 10px;"> <p>Note: <i>If you see the “Out of Range” message on the screen, then the OSD menu cannot be operated.</i></p> </div>	<ul style="list-style-type: none"> √ Change the resolution or the refresh rate of the graphics card.
 <p>▲ WARNING! CHANGING THE FOLLOWING SETTING IN OSD MENU MAY INCREASE THE POWER CONSUMPTION OF YOUR MONITOR. - BRIGHTNESS - COLOUR DO YOU WANT TO CONTINUE TO CHANGE? ACCEPT CANCEL</p>	<p>Increase the brightness and/or contrast may increase the power consumption of the monitor.</p>	<ul style="list-style-type: none"> √ Select “ACCEPT” to confirm or “CANCEL” to cancel the modifications.
 <p>Monitor will go into Standby mode.</p>	<p>The LCD monitor is in Standby mode. The LCD monitor will enter Standby mode when experiencing a sudden signal disconnecting problem.</p>	<ul style="list-style-type: none"> √ Check if the signal cable is properly connected. √ The monitor can be activated by pressing any keyboard, triggering the mouse, or touching the screen. √ Check if the correct source is selected in the OSD > System > Source Select menu. Refer to page 29.

CHAPTER 6: APPENDIX

6.2 Timing

Timing Mode	Resolution		Refresh Rate
	Horizontal	Vertical	
IBM VGA	640	480	60
VESA	800	600	60
VESA	1024	768	60
VESA	1280	800	60

6.3 Cleaning

Front Panel Cleaning Instructions

- The front of the monitor has been specially treated. Wipe the surface gently using only a cleaning cloth or a soft, lint-free cloth.
- If the surface becomes dirty, soak a soft, lint-free cloth in a mild detergent solution. Wring the cloth to remove excess liquid. Wipe the surface of the monitor to remove dirt. Then use a dry cloth of the same type to dry.
- Do not use volatile substances such as insect sprays, solvents and thinners.

Cabinet Cleaning Instructions

- If the cabinet becomes dirty, wipe the cabinet with a soft, dry cloth.
- If the cabinet is extremely dirty, soak a lint-free cloth in a mild detergent solution. Wring the cloth to remove as much moisture as possible. Wipe the cabinet. Use another dry cloth to wipe over until the surface is dry.
- Do not allow any water or detergent to come into contact with the surface of the monitor. If water or moisture gets inside the unit, operating problems, electrical and shock hazards may result.
- Do not scratch or hit the cabinet with fingers or hard objects of any kind.
- Do not use volatile substances such as insect sprays, solvents and thinners on the cabinet.
- Do not place anything made from rubber or PVC near the cabinet for any extended periods of time.

APPENDIX

6.4 Troubleshooting

Problems	Possible Cause and Solution
No picture.	<ul style="list-style-type: none"> • Check if the LCD monitor is turned ON. • Check if the power adapter is properly connected to the LCD monitor. • Check if the power cord is plugged into the power outlet and to the power adapter. • Check if the LCD monitor is properly connected to the input source. • Check if the input source is turned ON. • Check if the input source is in standby mode, move the mouse or press any key to wake it up. <div style="border: 1px solid black; padding: 5px; margin-top: 10px;"> <p>Note: Do not connect the USB cable to the LCD monitor in order to charge your laptop. Doing so will disable the LCD monitor to wake up from standby mode by simply touching the screen.</p> </div>
Partial image or incorrectly displayed image.	<ul style="list-style-type: none"> • Check to see if the resolution of your computer is higher than that of the LCD monitor. • Reconfigure the resolution of your computer to make it less than or equal to 1280 x 800.
The displayed texts are blurry.	<ul style="list-style-type: none"> • For VGA input, run the Auto Adjust function in Picture menu. Refer to page 26.
Red, blue, green, white dots appear on the screen.	<ul style="list-style-type: none"> • There are millions of micro transistors inside the LCD monitor. It is normal for a few transistors to be damaged and to produce spots. This is acceptable and is not considered a failure.
Faint shadows from a static image appear on the screen.	<ul style="list-style-type: none"> • Turn off the LCD monitor for extended periods of time. • Use a screen saver or a black and white image and run it for extended periods of time.
Dew formed on the LCD monitor.	<ul style="list-style-type: none"> • This normally happens when the LCD monitor is moved from a cold room to a hot room temperature. Do not turn ON the LCD monitor, wait for the dew condensation to disappear.

APPENDIX

6.5 Transporting the LCD Monitor

To transport the LCD monitor for repair or shipment, place the monitor in its original packaging box.

1. Place the two foam cushions on each side of the LCD monitor for protection.
2. Place the LCD monitor down in the box.
3. Place the bag with accessories on the designated area (if necessary).
4. Close and tape the box.

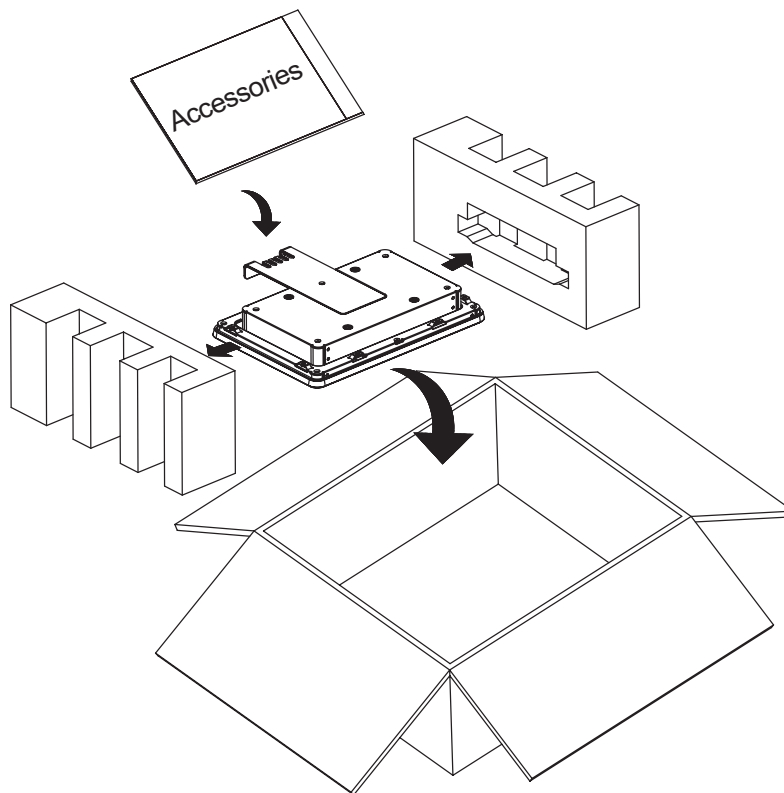

Note:

- *It is recommended to use the original packaging box.*
- *When repacking, carefully place the LCD monitor in its box and protect the glass panel from touching any object.*

CHAPTER 7: SPECIFICATIONS

7.1 Monitor Specifications

TX-10		
Panel	Panel Type	LED-Backlit TFT LCD (VA Technology)
	Panel Size	10.1"
	Max. Resolution	1280 x 800
	Pixel Pitch	0.169 mm
	Brightness	500 cd/m ²
	Contrast Ratio	1300:1
	Viewing Angle (H/V)	170°/170°
	Display Colour	16.2M
	Response Time	5 ms
Frequency (H/V)	H Freq.	31 kHz-50 kHz
	V Freq.	56 Hz-60 Hz
Input	DisplayPort	x 1
	HDMI	1.3a x 1
	VGA	15-Pin D-Sub x 1
External Control	RJ45	x 1 (Wired OSD Controller Port)
Audio	Audio Out	Stereo Audio Jack (3.5 mm)
Touch Screen	Technology	Projective Capacitive
	Positional Accuracy	± 2.5 mm
	Panel Interface	USB (Type-B)
	Multi-touch Plug & Play	10-point touch for Windows 7/8/10
	Single Touch Support by Driver	Windows VISTA/XP/2000/CE/XP Embedded, Mac OS 10.10-10.14
Multi-touch Support by Driver	10-point touch for Linux, Android 2.3-4.x	
Power	Power Supply	External
	Power Requirements	DC 12V, 1.0A
	On Mode	8W (On)
	Standby Mode	< 0.8W
	Off Mode	< 0.3W
Glass	Thickness	3.3 mm (0.13")
	Reflection Rate	< 12%
	Transmission Rate	> 85%
	Hardness	> 7H
Operating Conditions	Temperature	0°C-50°C (32°F-122°F)
	Humidity	20%-80% (non-condensing)
Storage Conditions	Temperature	-20°C-60°C (-4°F-144°F)
	Humidity	10%-90% (non-condensing)
Mounting	VESA FPMPMI	Yes (100 x 100 mm)
Dimensions	w/o Base (W x H x D)	260.7 x 183.4 x 39.4 mm (10.3" x 7.2" x 1.6")
	Packaging (W x H x D)	370.0 x 325.0 x 160.0 mm (14.6" x 12.8" x 6.3")
Weight	w/o Base	1.4 kg (3.1 lb)
	Packaging	2.4 kg (5.3 lb)

Note: All specifications are subject to change without prior notice.

SPECIFICATIONS

7.2 Monitor Dimensions

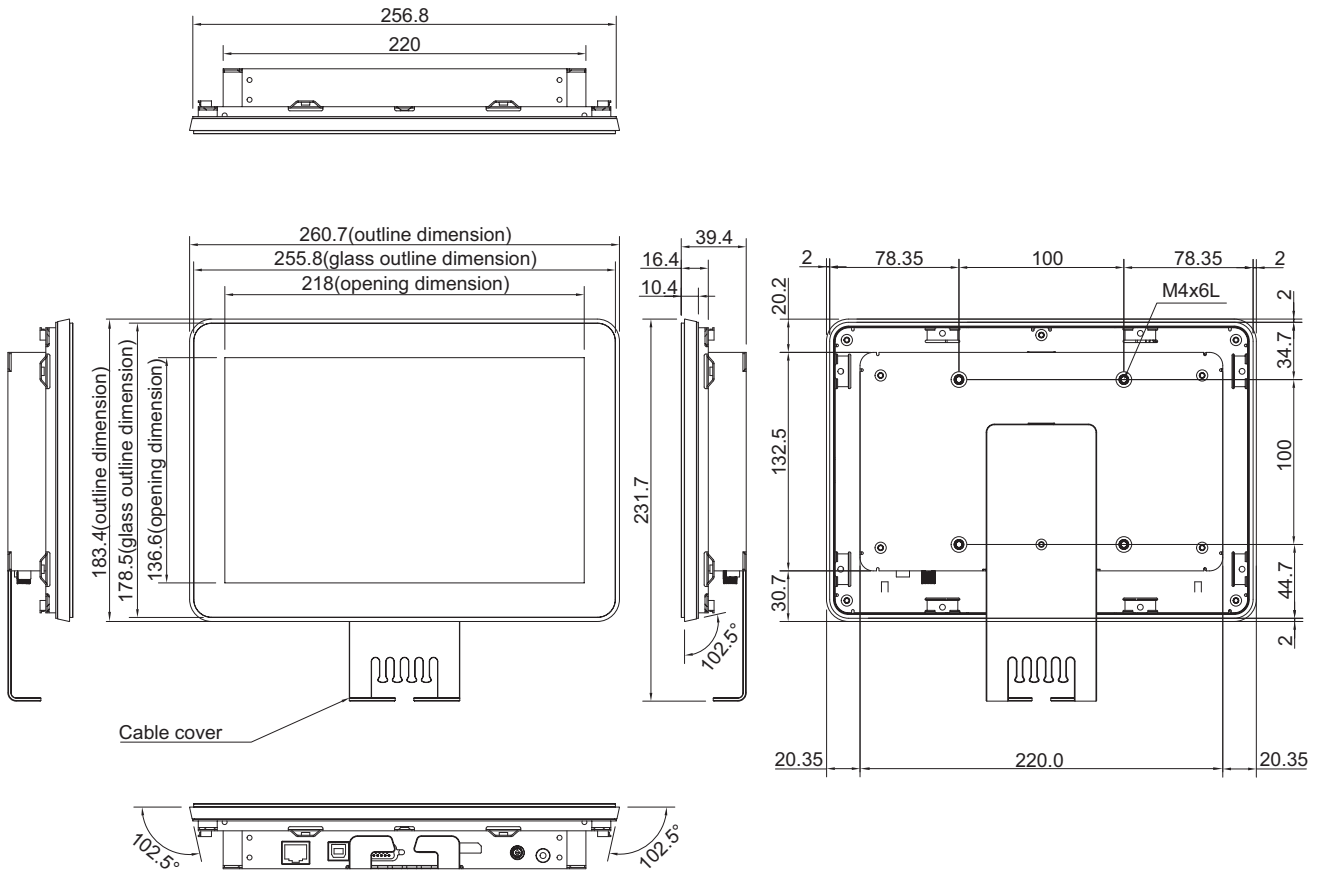

AG Neovo

Company Address: 5F-1, No. 3-1, Park Street, Nangang District, Taipei, 11503, Taiwan.

Copyright © 2021 AG Neovo. All rights reserved.

TX1000_UM_V013

TX-10 Eprel registration number : 456257